

7000Z FR 7000T4 TROUT 7000M1 SET

00700030C41

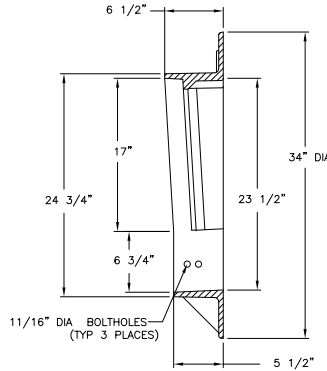

7000Z Curb Inlet Frame

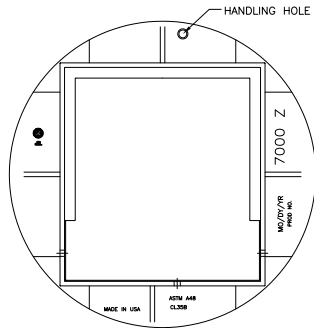

CROSS SECTION

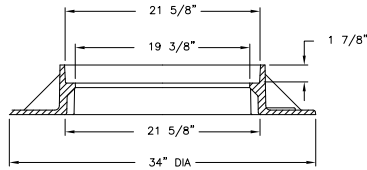

CROSS SECTION



Product Number

00700010

Design Features

- Materials
 - Gray Iron (CL35B)
- Design Load
 - Heavy Duty
- Open Area
 - n/a
- Coating
 - Dipped
- √ Designates Machined Surface

Certification

- ASTM A48
-
- Country of Origin: USA

Drawing Revision

01/30/2001 Designer: JJJ
2/24/2012 Revised By: DJH

Disclaimer

Weights (lbs./kg), dimensions (inches/mm) and drawings provided for your guidance. We reserve the right to modify specifications without prior notice.
CONFIDENTIAL: This drawing is the property of EJ GROUP, Inc. and embodies confidential information, registered marks, patents, trade secret information, and/or know how that is the property of EJ GROUP, Inc. Copyright © 2012 EJ GROUP, Inc. All rights reserved.

Contact

800 626 4653
ejco.com

00700010

Quantity: 1

7000M1 Grate

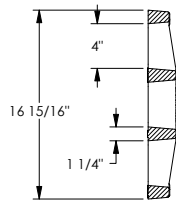
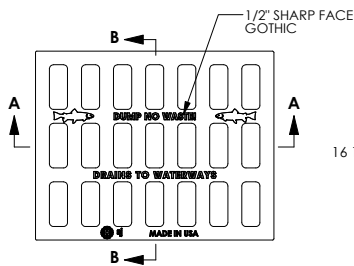

SECTION B-B

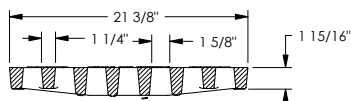

SECTION A-A

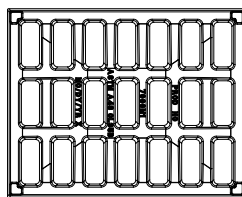

BOTTOM VIEW



Product Number

00700030

Design Features

- Materials
 - Gray Iron (CL35B)
- Design Load
 - Heavy Duty
- Open Area
 - 135 sq in
- Coating
 - Dipped
- √ Designates Machined Surface

Certification

- ASTM A48
-
- Country of Origin: USA

Drawing Revision

1/5/2005 Designer: DEW
05/31/2013 Revised By: DJH

Disclaimer

Weights (lbs./kg), dimensions (inches/mm) and drawings provided for your guidance. We reserve the right to modify specifications without prior notice.
CONFIDENTIAL: This drawing is the property of EJ Group, Inc. and embodies confidential information, registered marks, patents, trade secret information, and/or know how that is the property of EJ Group, Inc. Copyright © 2014 EJ Group, Inc. All rights reserved.

Contact

800 626 4653
ejco.com

00700030

Quantity: 1

Supplied By:



877-903-7246

www.trenchdrainsupply.com

Disclaimer

Weight (lbs./kg), dimensions (inches/mm) and drawings provided for your guidance. We reserve the right to modify specifications without prior notices

CONFIDENTIAL: This drawing is the property of EJ GROUP, Inc., and embodies confidential information, registered marks, patents, trade secret information, and/or know how that is the property of EJ GROUP, Inc. Copyright © 2014 EJ GROUP, Inc. All rights reserved

Contact

800 626 4653
ejco.com

7000Z FR 7000T4 TROUT 7000M1 SET

00700030C41



00700066

Quantity: 1

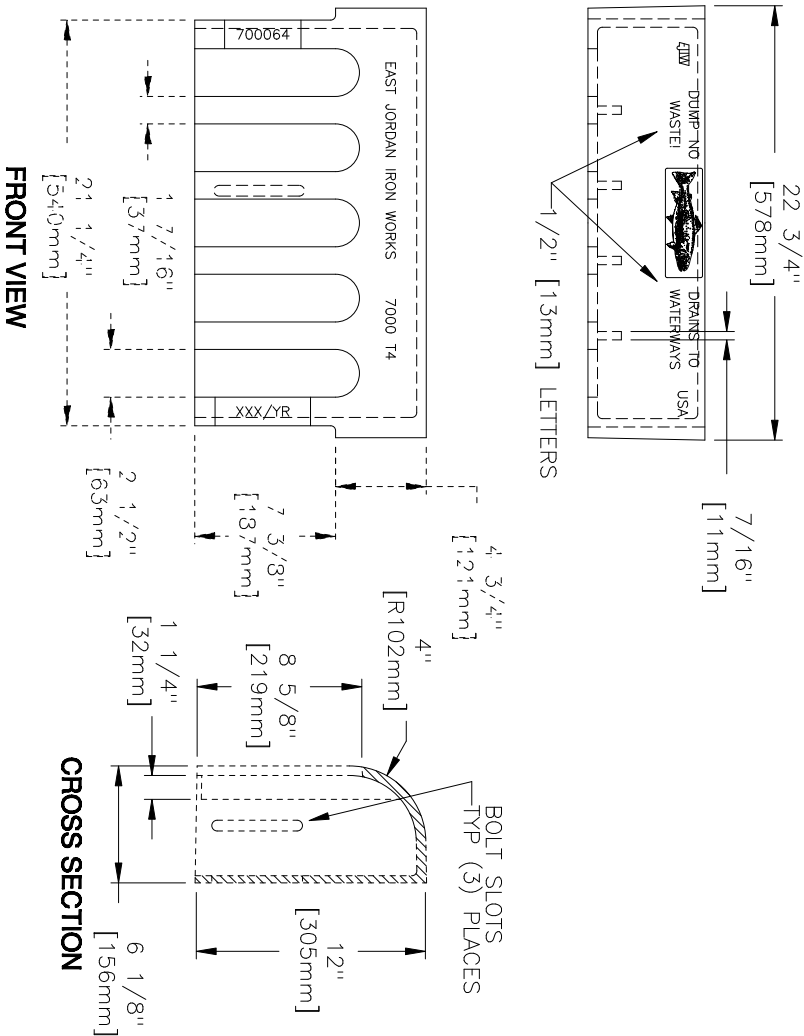

EAST JORDAN IRON WORKS, INC.
 P.O. BOX 439
 EAST JORDAN, MI. 49727
 1-800-874-4100
 FAX 231-536-4458

DRAWN	DATE
SBB	12/12/03
APPROVED	DATE

7000T4 BACK

PRODUCT NO.
00700066

CATALOG NO.
7000T4

REF. PRODUCT DRAWING
 700064

EST. WT.
 BACK : 80 LBS 36 kg

OPEN AREA
 N/A

MAT'L SPEC.
 BACK - GRAY IRON
 ASTM A48 CL35

LOAD RATING
HEAVY DUTY

Disclaimer

Weight (lbs./kg), dimensions (inches/mm) and drawings provided for your guidance. We reserve the right to modify specifications without prior notices

CONFIDENTIAL: This drawing is the property of EJ GROUP, Inc., and embodies confidential information, registered marks, patents, trade secret information, and/or know how that is the property of EJ GROUP, Inc.
Copyright © 2014 EJ GROUP, Inc.
All rights reserved

Contact

800 626 4653
ejco.com